

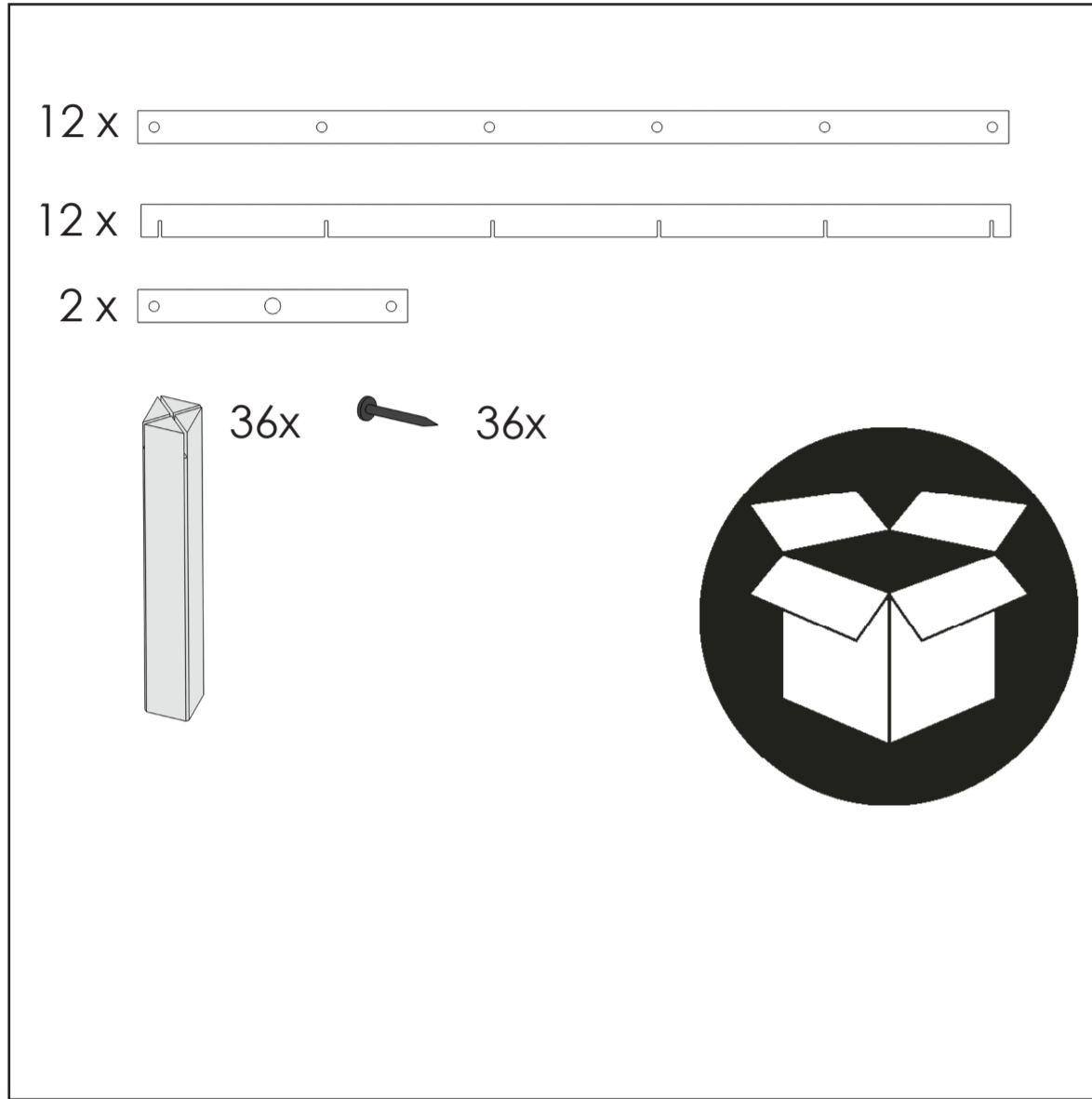

WINERACKS



GERMAN

WICHTIG: WEINREGAL AUF EINER HARTEN, EBENEN GRUNDLAGE MONTIEREN
ACHTUNG: DIESES WEINREGAL IS NICHT FÜR WANDMONTAGE BESTIMMT

SPANISH

IMPORTANTE: MONTAR EL BOTELLERO EN UNA SUPERFICIE LISA Y DURA
ADVERTENCIA: ESTE BOTELLERO NUNCA DEBE COLGARSE EN LA PARED

DUTCH

BELANGRIJK: DIT WIJNREK MOET OP ENN HARDE EN VLAKKE VLOER GEPLAATSE WORDEN
OPGELET: DIT WIJNREK KAN NIET AAN DE MUUR OPGEHANGEN WORDEN

ENGLISH

IMPORTANT: ASSEMBLE ON A HARD, FLAT SURFACE
WARNING: THIS WINE RACK MUST NEVER BE WALL-MOUNTED

FRENCH

IMPORTANT: L'ASSEMBLAGE DU CASIER DOIT ÊTRE FAIRE SUR UNE SURFACE DUR ET PLATE
ATTENTION: CE RACK À VIN DOIT TOUJOURS ÊTRE PLACÉ SUR LE SOL

ITALIAN

IMPORTANTE: MONTAGGIO SU UNA SUPERFICIE DURA E PIATTA
ATTENZIONE: QUESTA CANTINETTA NON DEVE MAI ESSERE APPESA ALLA PARETE, MA DEVE ESSERE APPOGGIATA A TERRA

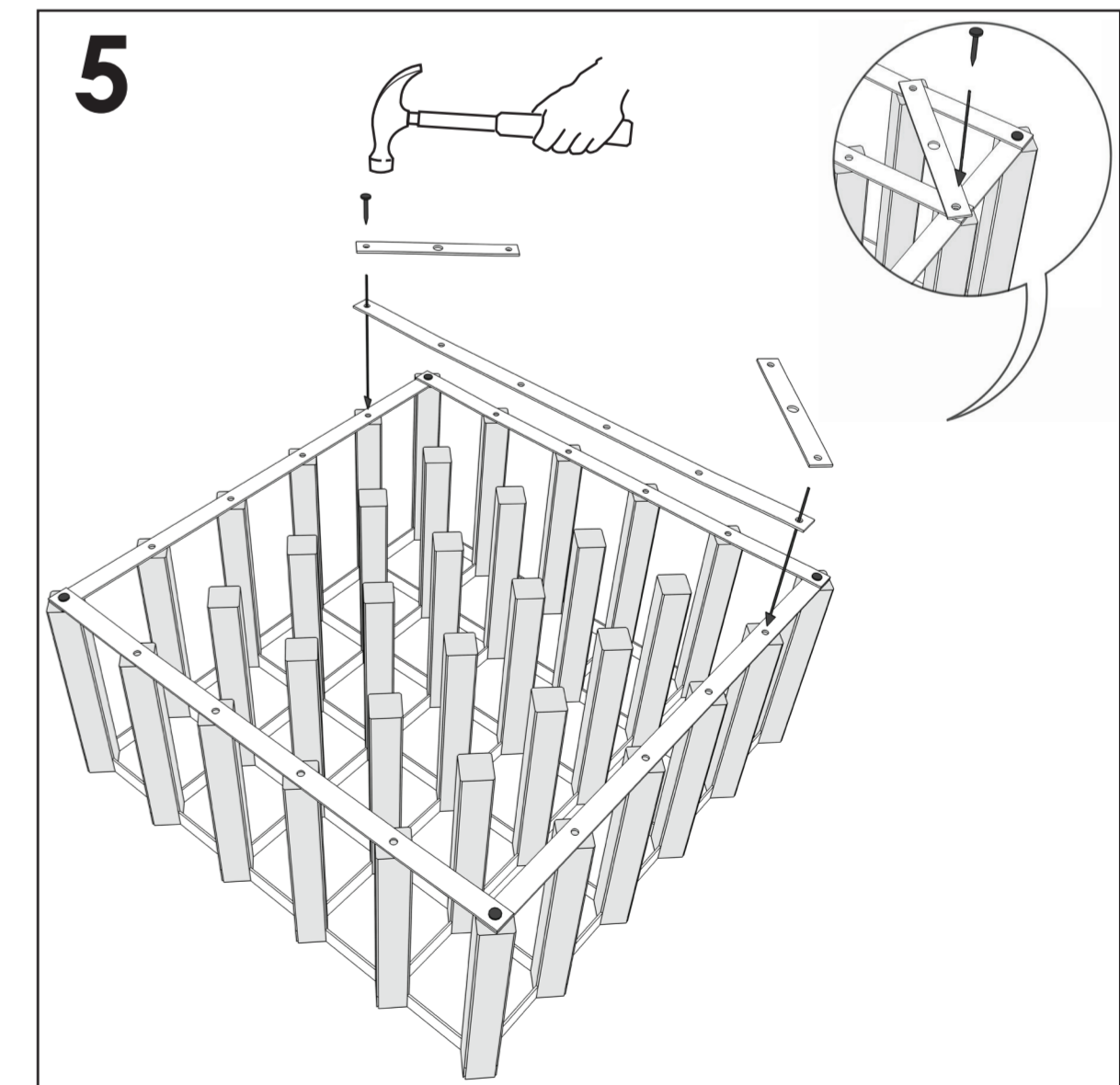
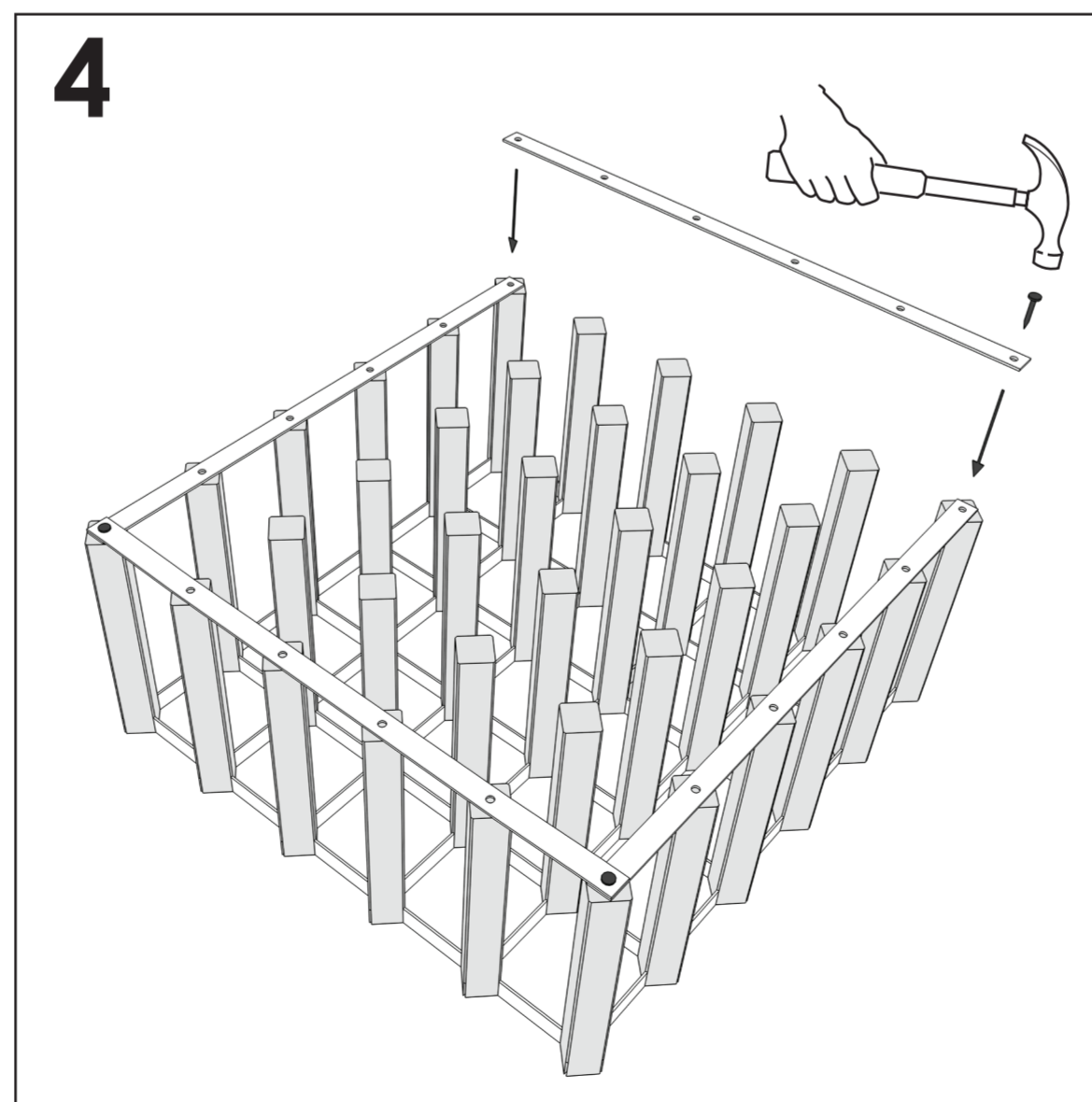
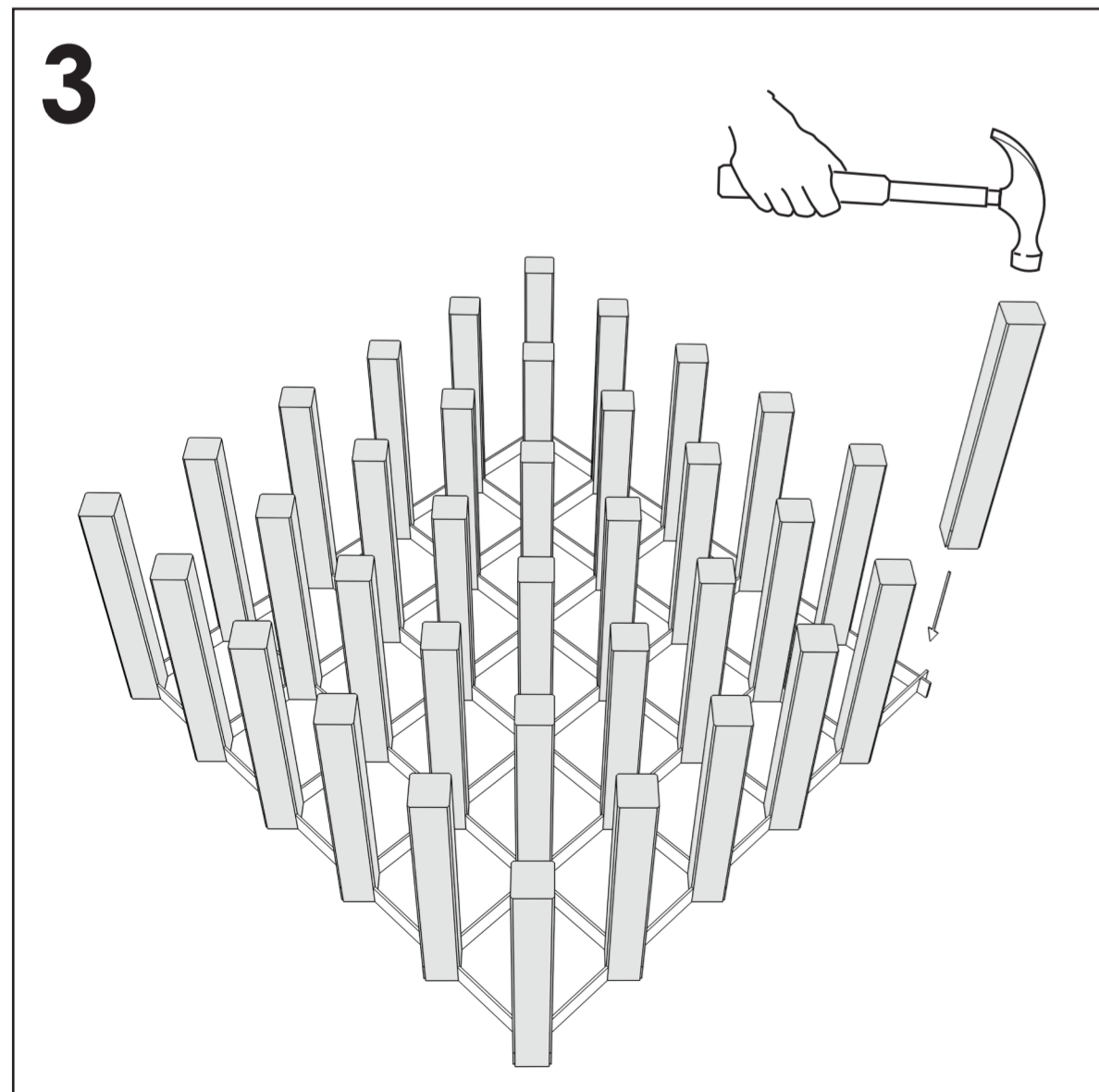
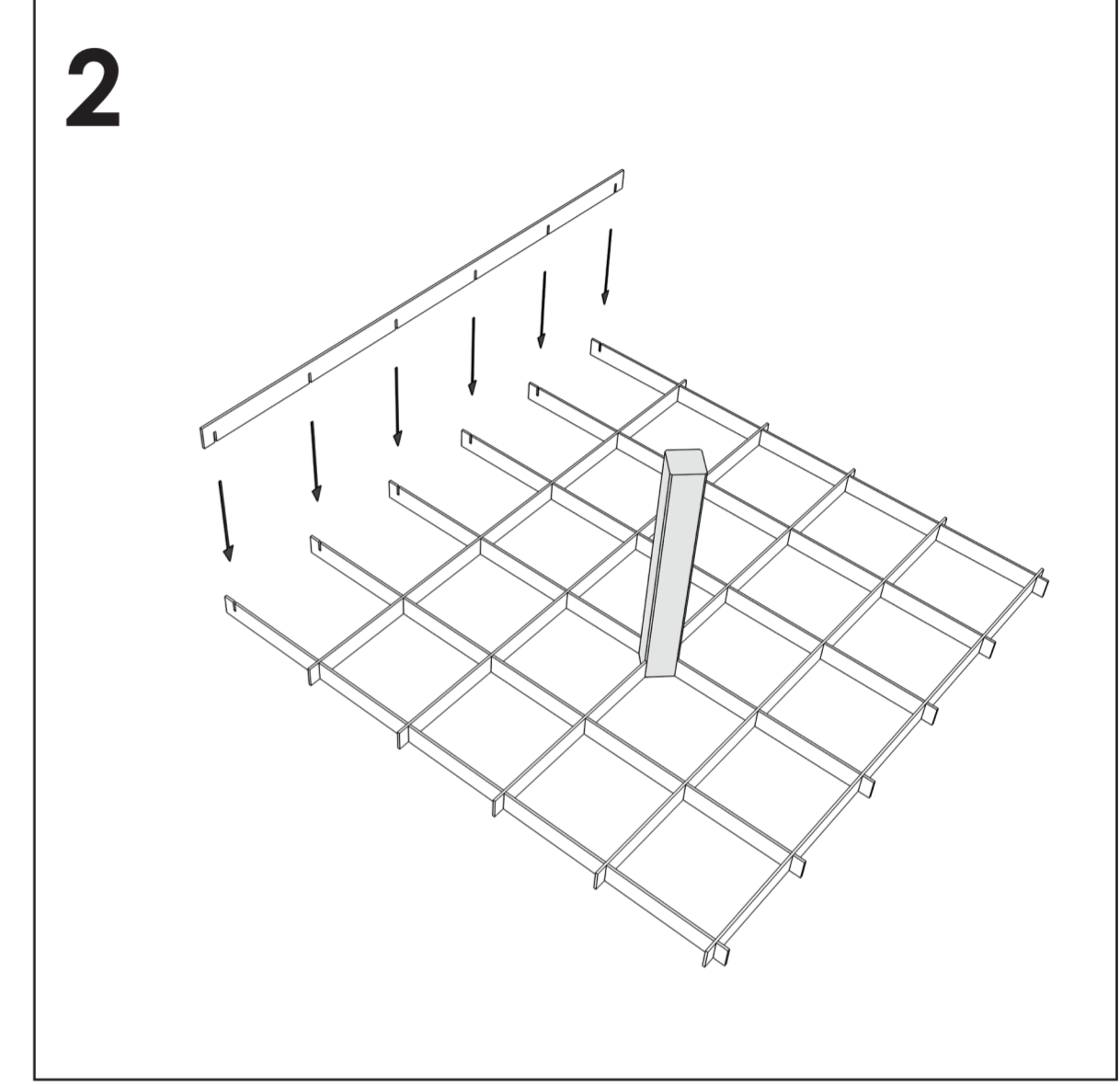
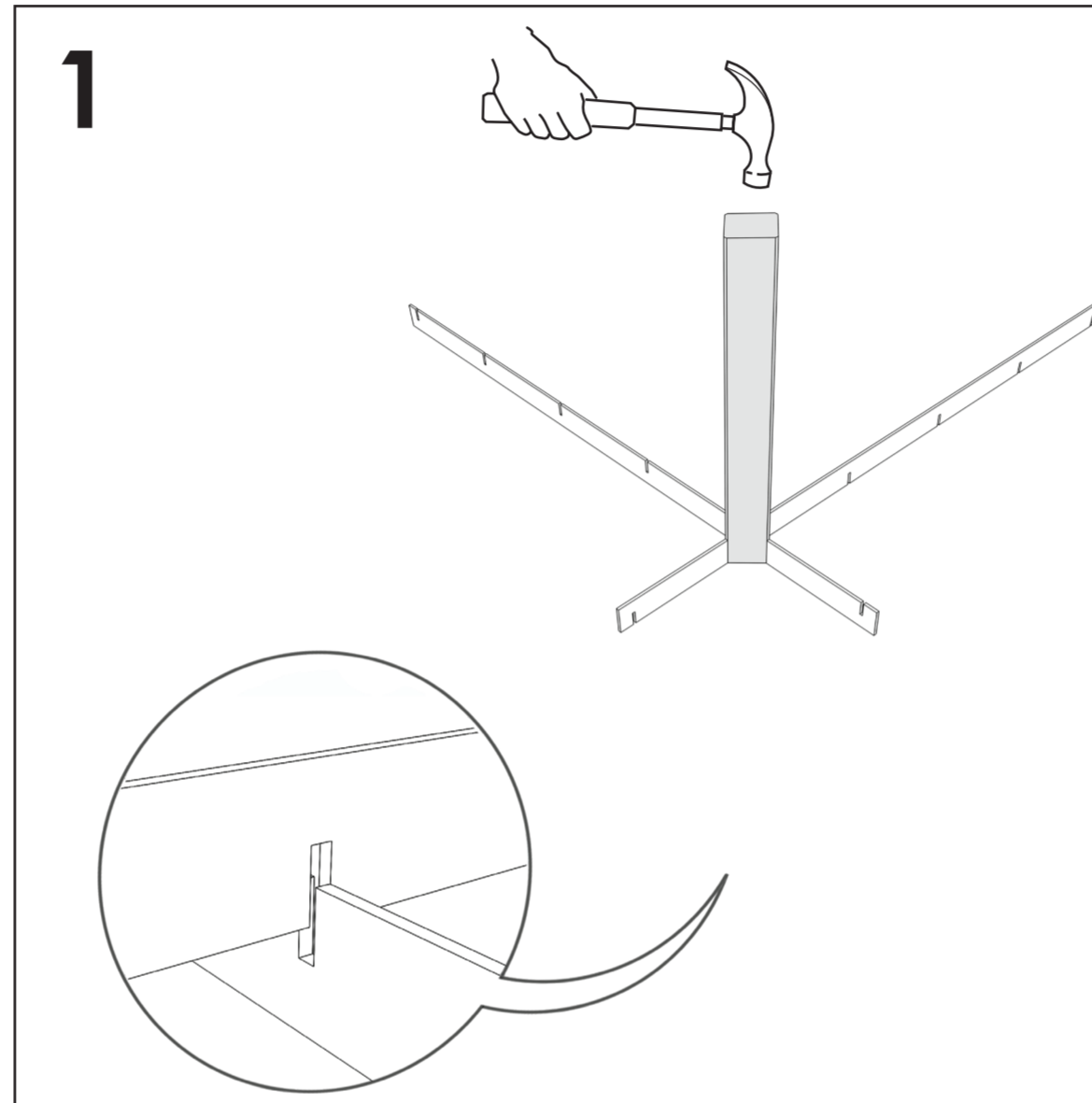



WINERACKS

30 Bottle Traditional Wine Rack

Assembly Instructions

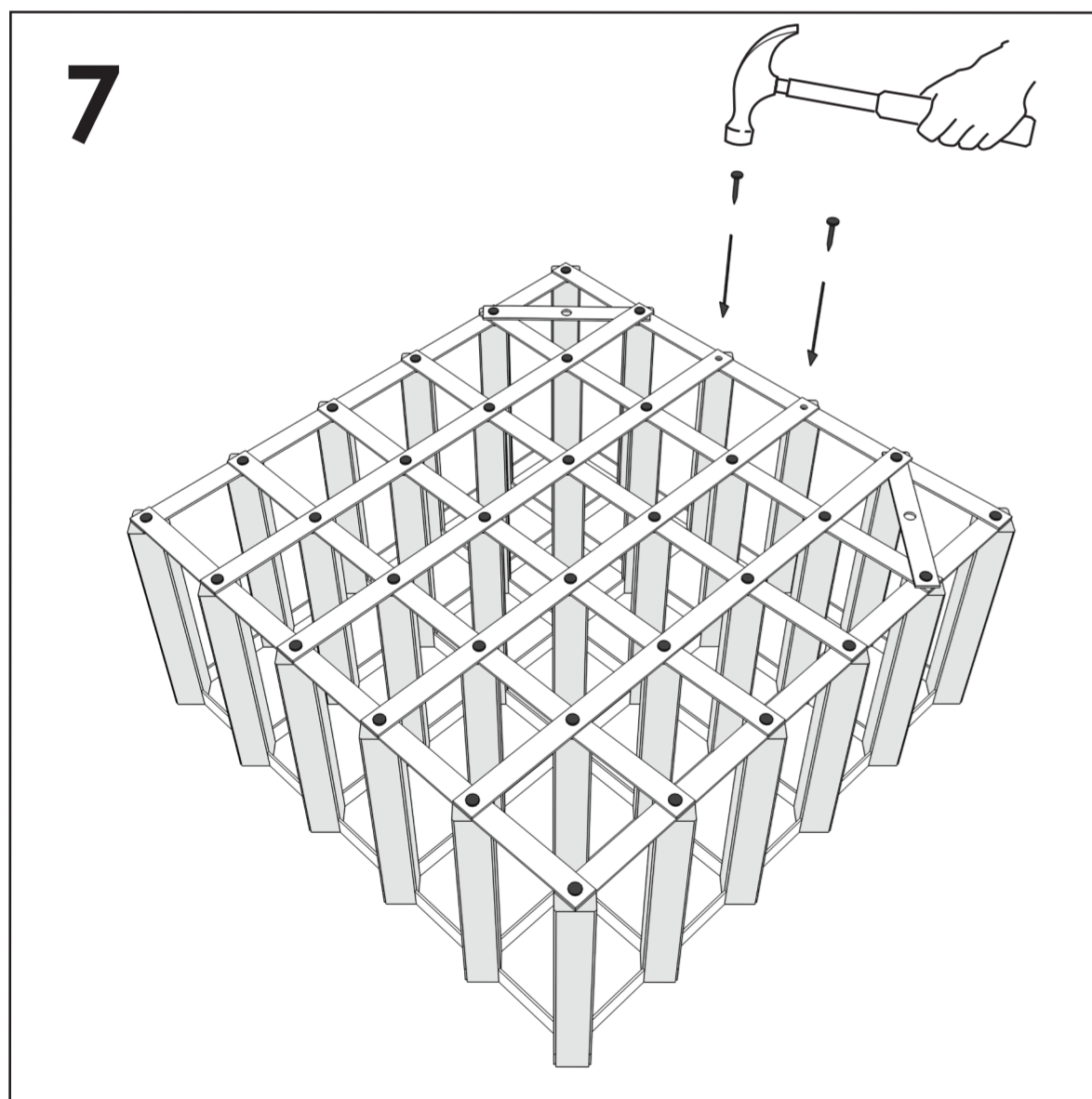
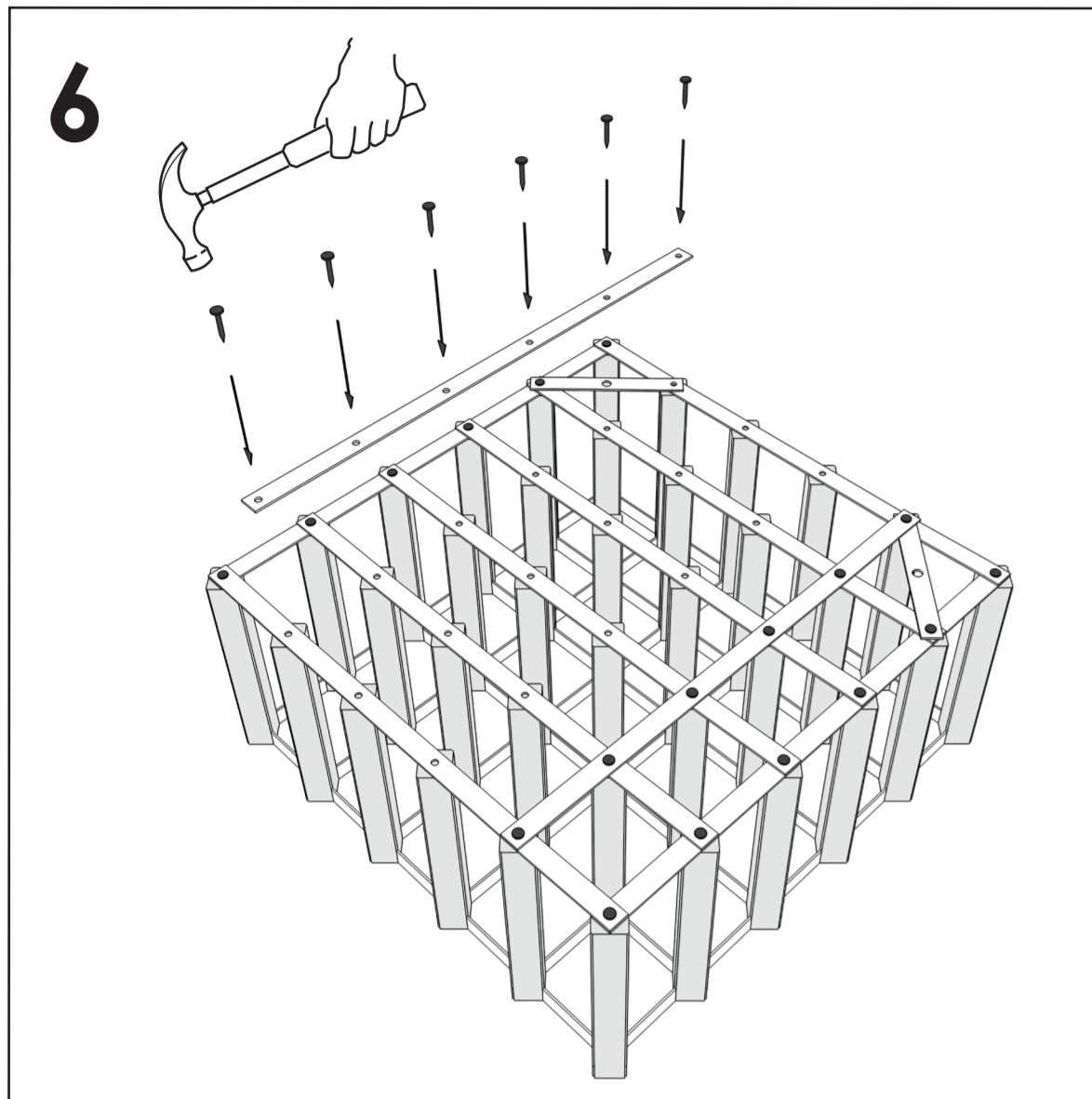

RTA Global Ltd
163 Alexandra Road
Gateshead
NE8 1RB
United Kingdom

Tel +44 (0)191 707 0101
Fax +44 (0)191 707 0100
Email sales@rtaglobal.co.uk
www.rtaglobal.co.uk