

BARRY

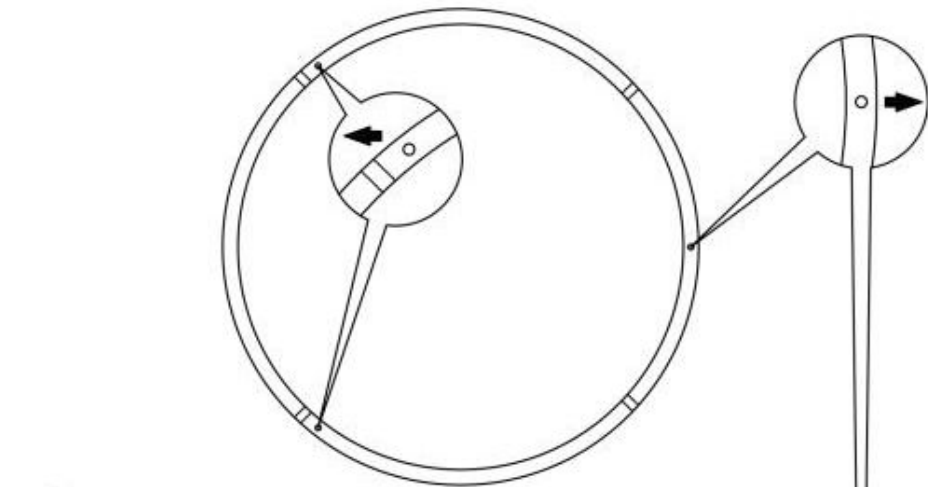

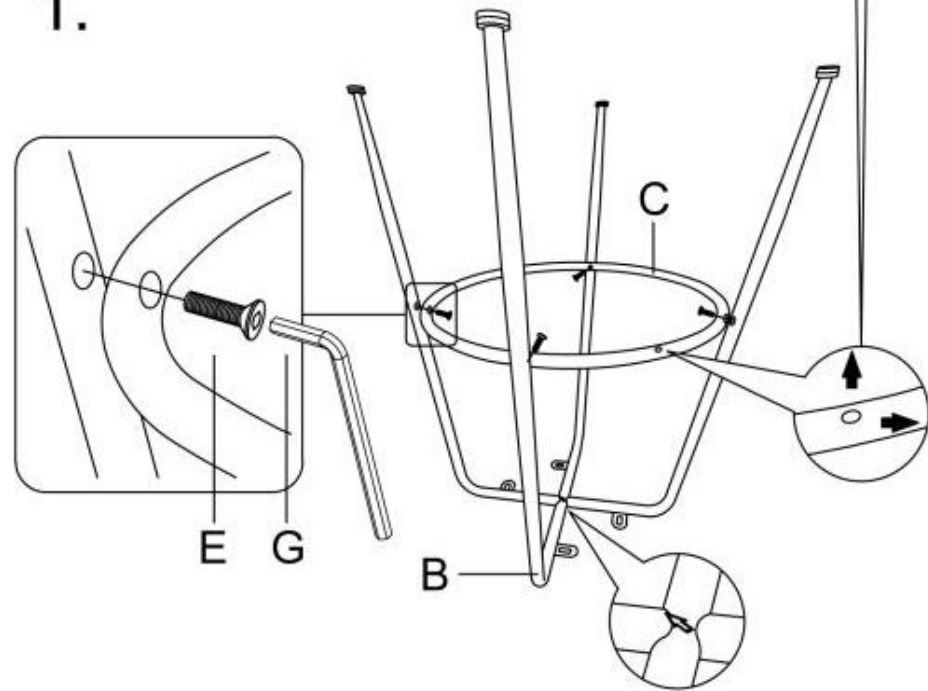





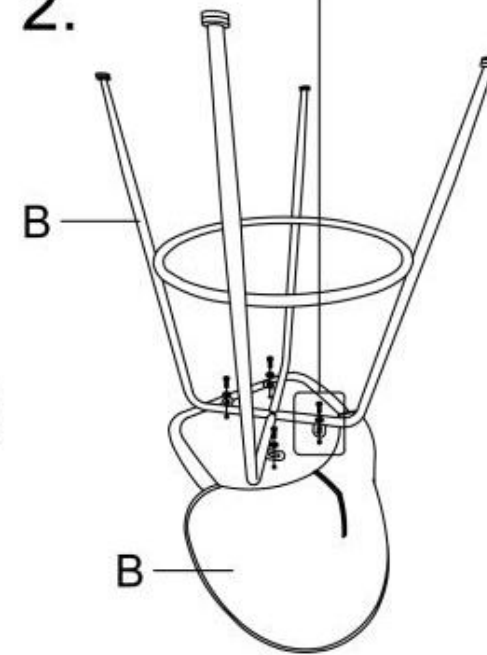

1.



2.



A		1
B		1
C		1
D	 M6*16*1 2MM	4
E	 M6*25MM	4
F	 M6*16MM	4
G	 #4	1

 max. 100 kg

