

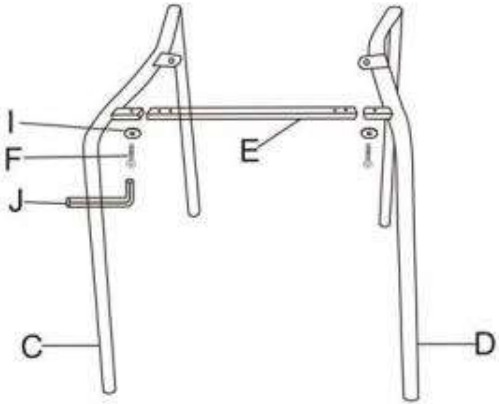

K-461

1

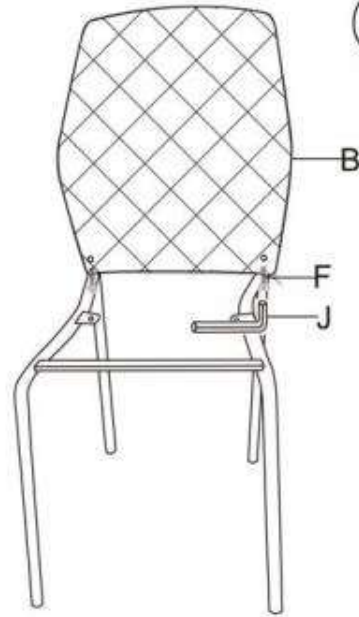

2









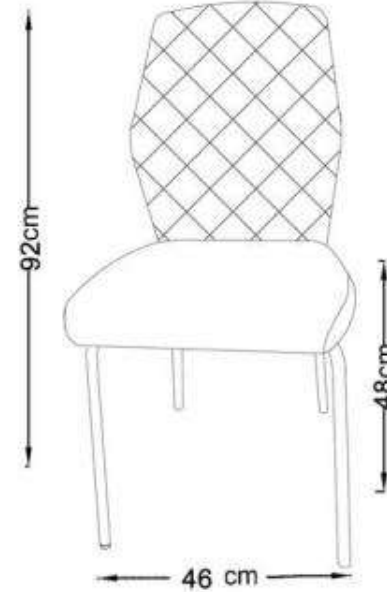
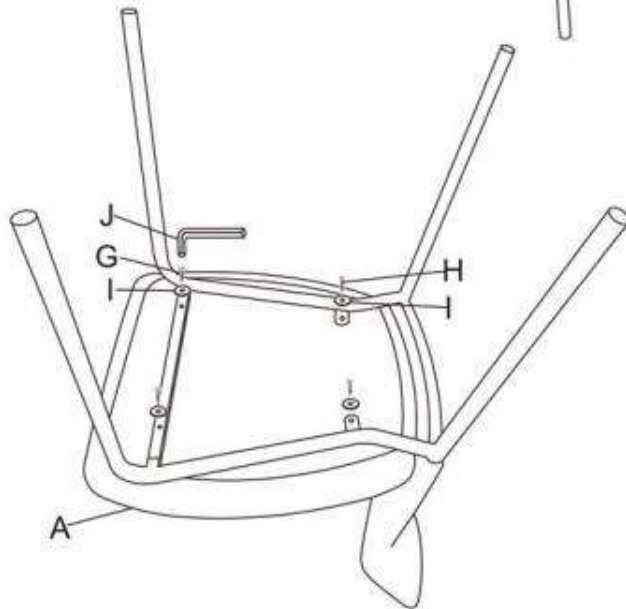



 max. 120 kg



3



A		X1
B		X1
C		X1
D		X1
E		X1
F	 M6X12	X4
G	 M6X30	X2
H	 M6X20	X2
I	 $\phi 6 \times \phi 16 \times 1.5$	X6
J	 M5	X1