







<p>E</p>  <p>8x</p>	<p>F</p>  <p>12x</p>	<p>G</p>  <p>$\Phi 8 \times 35 \text{mm}$ 20x</p>
<p>H</p>  <p>4x</p>	<p>I</p>  <p>12x</p>	<p>J</p>  <p>2x</p>



2

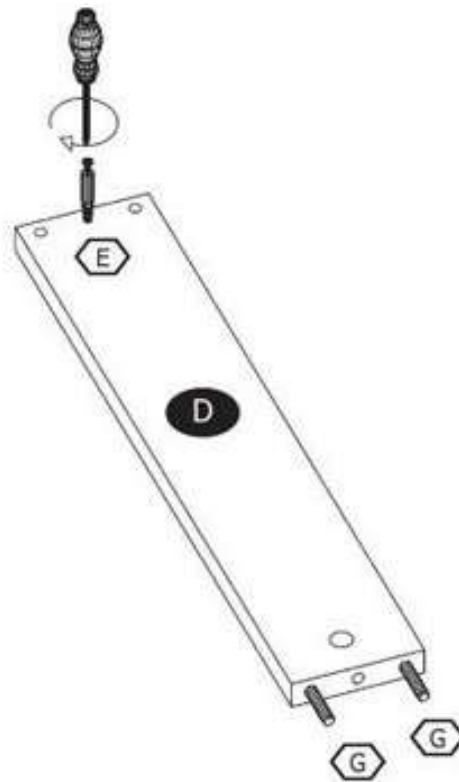
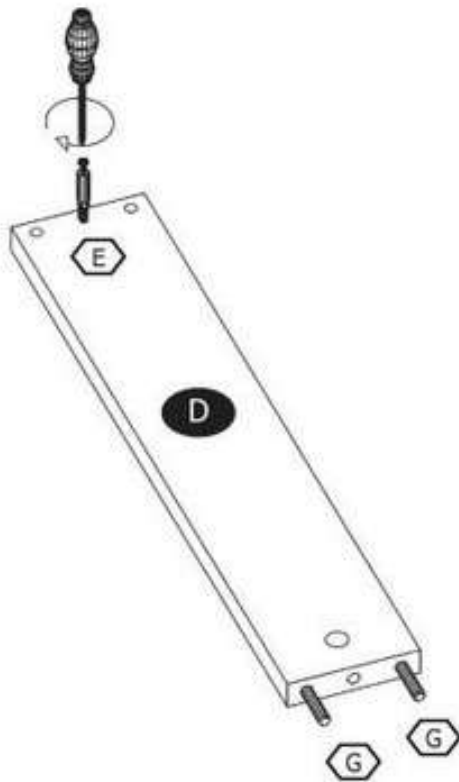
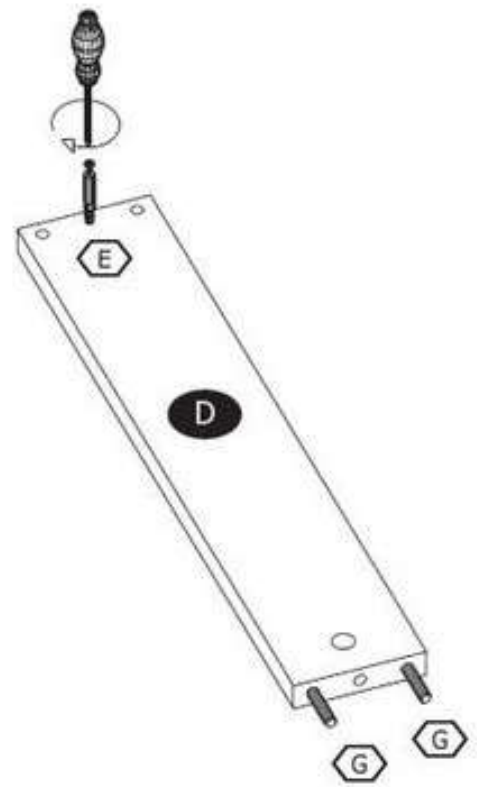
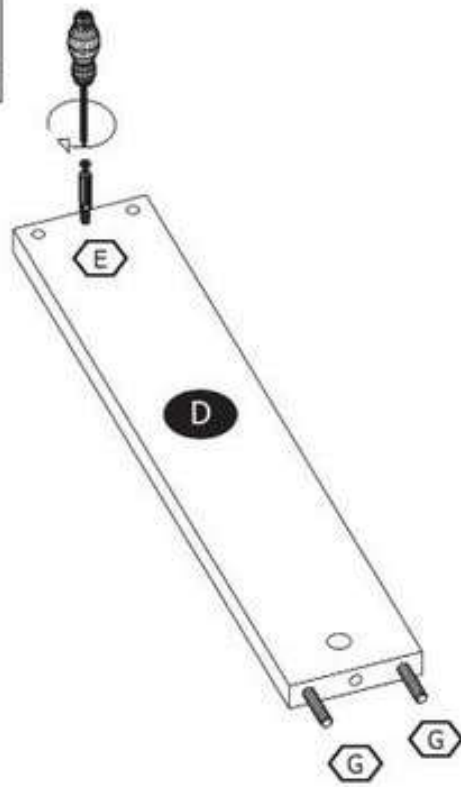
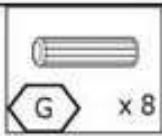
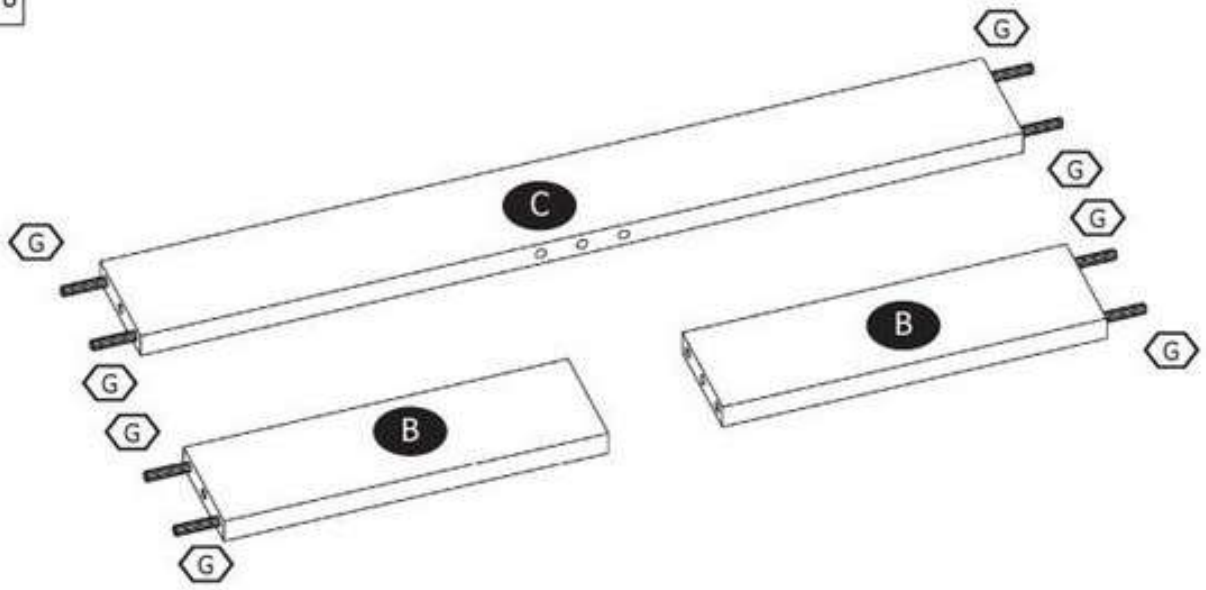
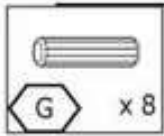

2

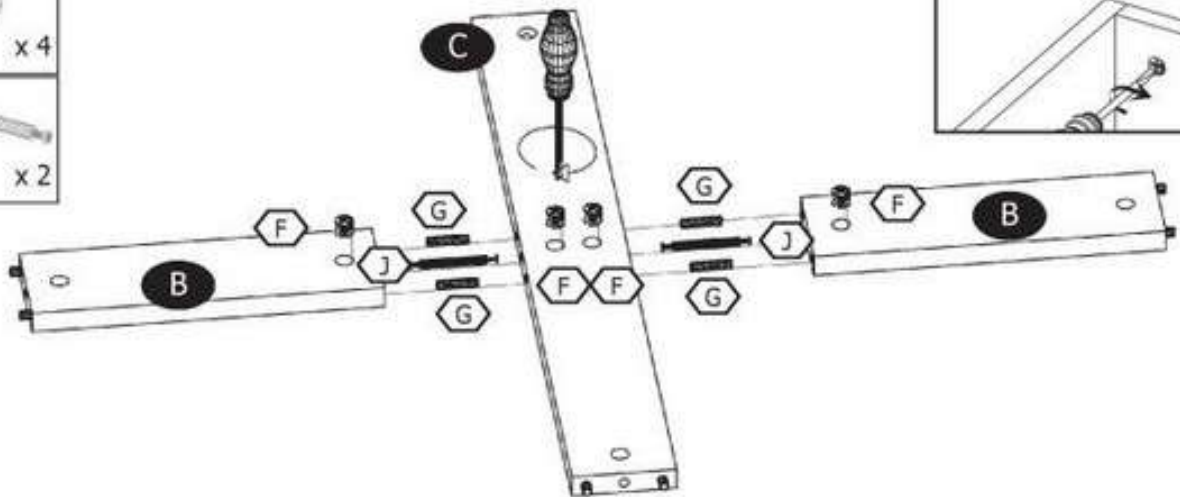
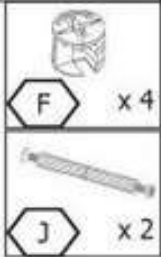
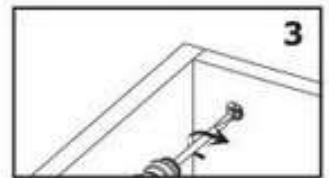
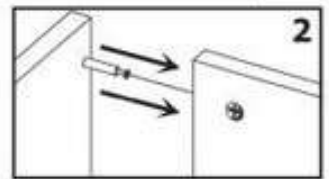
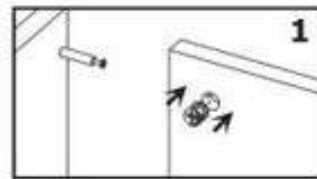
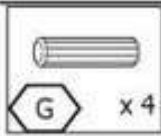

3

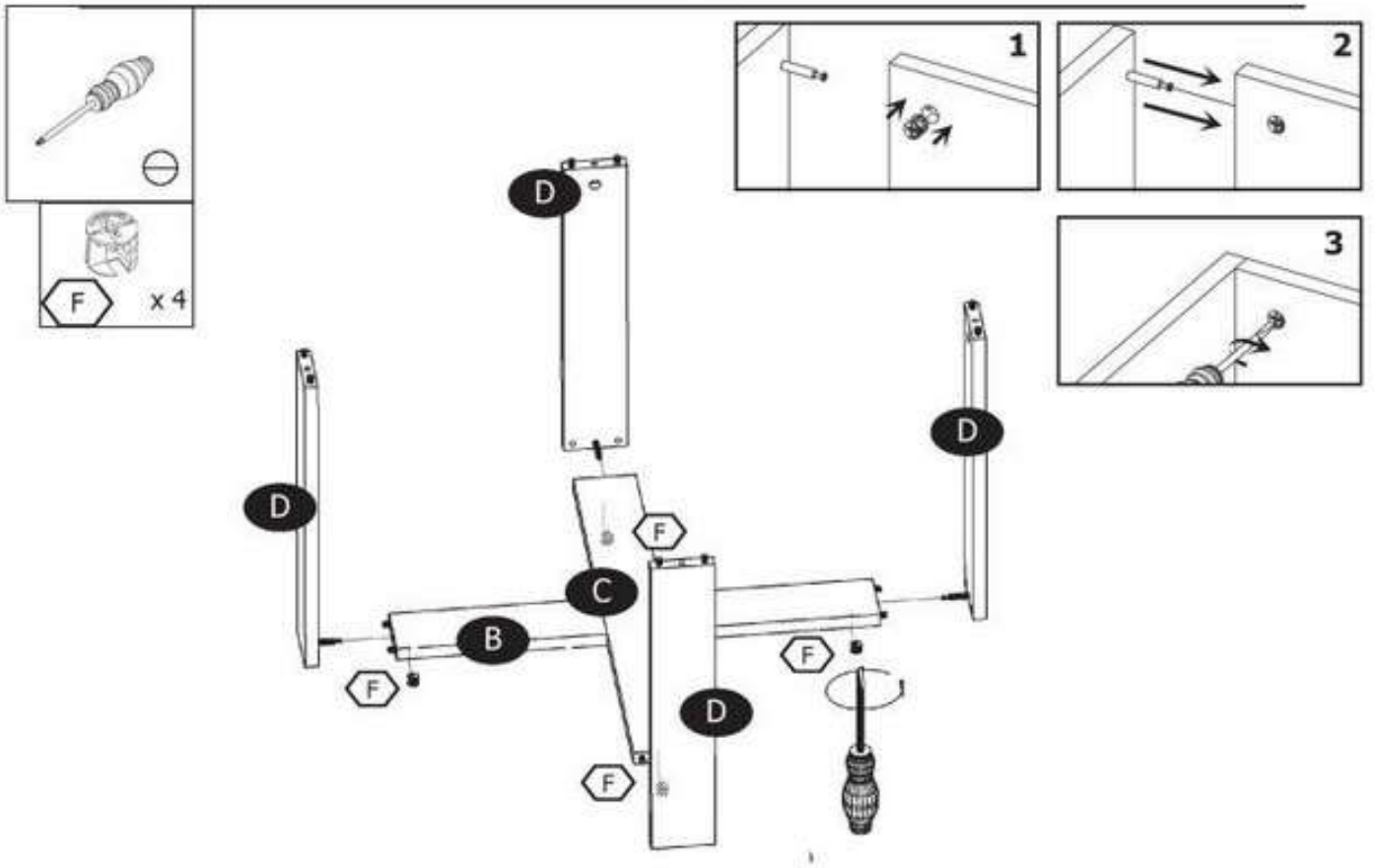

4

